

You Won't Believe Your Eyes



Océ Arizona Series UV flatbed printers

Technology backgrounder



“No compromise” printing

Océ Arizona® Series printers offer breakthrough performance to deliver “no compromise” printing for a variety of applications. Each model uses UV curable inks and Océ VariaDot® imaging technology to deliver near-photographic image quality. Each is built on a true flatbed architecture to print on almost any rigid media or object, and some feature a Roll Media Option for printing onto flexible materials. There are a number of significant technological advances included in the Océ Arizona family of printers, and this backgrounder will explain their functionality and benefits.

RECOGNIZED FOR EXCEPTIONAL IMAGE QUALITY

All Océ Arizona Series printers share the same award-winning image quality and robust architecture, reflecting our values of quality, reliability, productivity, and user-friendliness. Since the introduction of the Océ Arizona 250 GT printer in 2006, Océ Arizona Series UV flatbed printers have to date earned 38 industry awards from organizations throughout the world. These awards validate the quality and innovation built into every Océ Arizona Series printer.

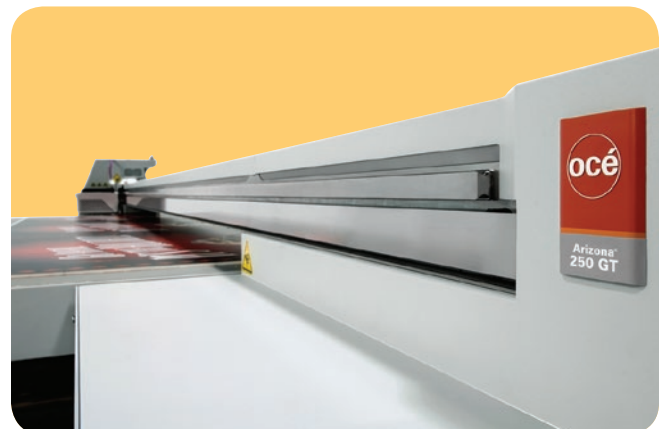



Océ VariaDot imaging technology



Fixed Dot Printing



Variable Dot Printing

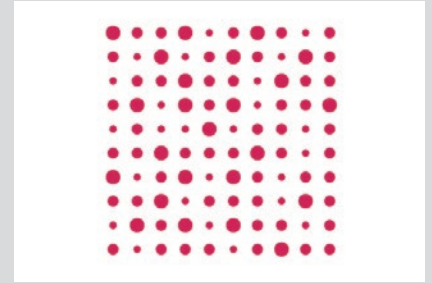

Variable Dots need not fill pixel space

OCÉ VARIADOT IMAGING TECHNOLOGY

With their outstanding image quality, Océ Arizona Series printers give professional print service providers the ability to offer premium printing services. The realistic, photo-like image quality is due to Océ VariaDot imaging technology. It uses variable-sized droplets to deliver finer details and smoother gradients in highlight areas, as well as crisp colors in the mid-tones and incredible density in shadows and areas of solid color.

Océ VariaDot imaging technology creates these variable dots by delivering ink droplets that vary in size from 6 to 42 picoliters. The ability to vary the drop size to as little as six picoliters produces sharp images with smoother gradients and quartertones *by placing a small and varying amount of ink at every pixel location* without completely filling the pixel space with color. The ability to jet larger droplets up to 42 picoliters enables the printer to saturate the entire pixel space resulting in the production of uniform, solid colors. The result is near-photographic image quality with sharpness only before seen at resolutions of 1,440 dpi or higher.

Every Océ Arizona printer can repeatedly print perfectly registered, multi-color, six-point text. With this image quality, users can deliver stunning point-of-purchase materials, banners, exhibit graphics, displays, and more. In addition, shops can print these near-photographic images on a wide range of rigid or flexible material to meet diverse customer needs. Models equipped with High Definition print mode can produce perfect 2-point text and have the geometric accuracy and feature resolution needed to support technical and industrial applications with ease.

UP TO 50% IN INK SAVINGS

In addition to superior image quality, the Océ Arizona 318 and Océ Arizona 400 or Océ Arizona 600 Series printers equipped with Océ VariaDot imaging technology rely on only four colors of ink (CMYK), and use significantly less ink compared to six color (CMYKcm) printers with fixed-droplet inkjet technology. The combination of using variable sized droplets to produce quartertones and fine image details using only four colors, results in ink consumption up to 50 percent lower than fixed-droplet, six color printers. Océ Arizona Series printers use **less than 8 ml of ink for every square meter (0.74 ml per square foot)** of printing on average as measured by customers. This is a measured average over millions of printed square meters, not a theoretical concept. It even includes ink used for maintenance.



OPTIMIZED WORKFLOW

TRUE FLATBED

Each Océ Arizona Series printer is a true flatbed device that uses a vacuum system to hold media stationary on a flat surface, ensuring accurate registration even on multiple imaging passes. It incorporates precise linear position encoders providing constant feedback to ensure consistent image quality and repeatability. The flatbed table architecture is perfectly repeatable and is so geometrically accurate that a diagonal line measured corner-to-corner across an XT- or XTS-sized table 98.4×120.1 inches (2.5×3.05 m) will vary from theoretical length by no more than 0.039 inches (1 mm).

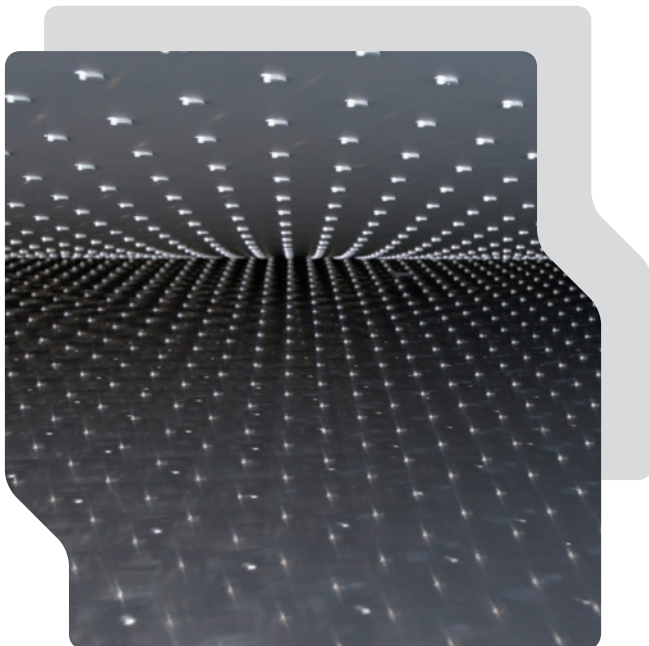

SYSTEM FLATNESS

Every Océ Arizona printer is built to meet a system flatness specification of only 0.0137 inches (350 microns) over the entire printing area. This means that the highest point in the entire flatbed system is no more than 350 microns from the lowest point. The extraordinary attention to detail to meet this crucial specification means that the printing gap—the distance between the printhead assembly and the media surface—is incredibly uniform. This constant print gap ensures sharp, uniform, density-constant images, wherever they happen to be printed on the flatbed or RMO and enables all that to happen bi-directionally for optimal throughput.

ACTIVE PIXEL PLACEMENT COMPENSATION FOR ASSURED IMAGE SHARPNESS

Within the 350 micron system flatness specification, the Océ Arizona 400 Series, 600 Series, and 6100 Series models use Océ's new *active pixel placement compensation* to assure image sharpness, density, and uniformity, whether it is printed on the flatbed or on the Roll Media Option. This is achieved by dynamically adjusting the location of individual pixels to account for localized variations in flatbed or platen height.

REAL-WORLD SYSTEM ORIENTATION

Océ Arizona Series models print along the long axis of rigid media to optimize throughput—the fewer the number of printing passes over the media, the higher the average productivity. This becomes most evident when printing a 49.2×96.4 inch (125×250 cm) rigid board during which the printer is only required to print 49.2 linear inches (125 linear cm), when most competitive systems would be forced to print 96.4 linear inches (250 linear cm).



A precision height adjustment feature is included for “no-guessing” height control of rigid media up to 2.0 inches (50.8 mm)*. Edge-to-edge (full bleed) prints are easily produced by the pallet-load, saving time and labor costs in finishing. Unlike pinch roller or belt-drive systems, there is no need to clean the drive system of excess ink between prints. *1.89" (48 mm) on the Océ Arizona 318 GL printer

EXTRA LARGE TABLE ENABLES NON-STOP PRODUCTIVITY

The extra large size of Océ Arizona XT and XTS printer models support the printing of oversized sheets and objects up to 98.4 × 120 inches (250 × 305 cm) in size. Two independent vacuum systems in Océ Arizona XT and XTS printer models also enable the printer to be used in a continuous imaging mode for rigid media up to 49.2 × 96.4 inches (125 × 250 cm, or a standard four- by eight-foot board). Two rigid boards can be placed on different areas of the flatbed table. While one board is being printed, the operator can change the other. Since the system never has to stop printing for a media change, no time is lost between prints and significantly higher net productivity can be achieved.

PRECISE PLACEMENT

The Océ Arizona 6100 Series printers are designed for optimum productivity and to assist in quickly loading boards onto the table in perfect, repeatable registration, the Océ Arizona 6100 Series feature a set of five pneumatic registration pins for each of the two independent vacuum zones.

PRINT ZONE ENHANCEMENTS

The printhead assembly includes an Océ-designed UV lamp system in which the lamp reflectors also serve as active shutters. When in the open position, they accurately focus UV energy on the media surface to cure the ink. When in the closed position, they protect the operator and the printheads from excessive UV exposure. This design also eliminates the by-product of static discharge caused by brush style shields used in competitive products resulting in less static build up on the media and fewer resulting printing artifacts.

NOTHING TO HIDE

The open carriage design of Océ Arizona Series printers enables users to see the print as it develops. Surrounding the carriage is a sensed, aluminum carriage guard designed to protect the printer from media collisions by immediately stopping motion if disrupted. This also protects the user from injury should he or she inadvertently do the same.

USER-CUSTOMIZABLE VACUUM SYSTEM

All Océ Arizona printers feature multiple vacuum zones—the number of zones varies by model—that are matched to fit the media size being printed. Controlled by valve handles located at the back of the printer, the vacuum zones can be turned on or off by the operator. A convenient vacuum pump foot switch enables hands-free activation of the vacuum enabling the operator to precisely place substrates on the table and hold them in place while activating the system.

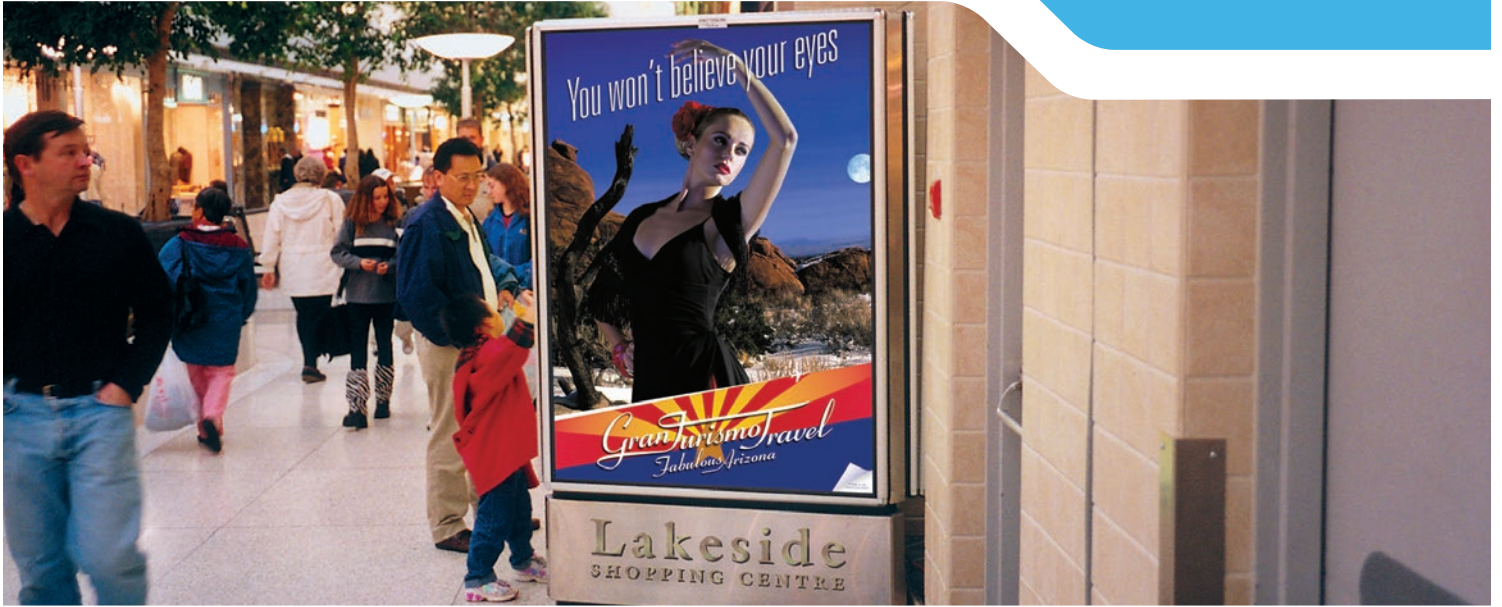

Multiple zones on Océ Arizona 400, 600, and 6100 Series models

There are six vacuum zones on Océ Arizona GT Series and seven on Océ Arizona XT or XTS Series models. These additional zones have been configured to match the majority of standard-sized graphic arts media to reduce or eliminate manual masking, thereby decreasing operator intervention and increasing productivity.

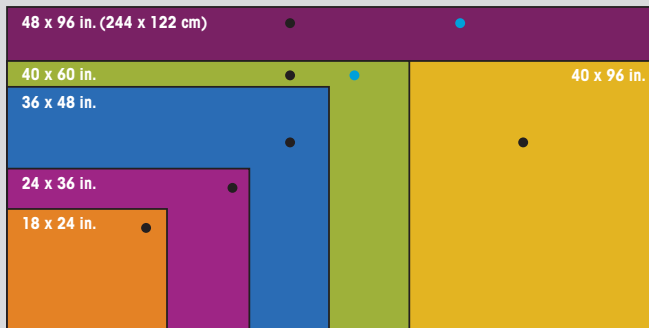

Océ Arizona 400 GT Series and Océ Arizona 600 GT Series U.S. overlay zones

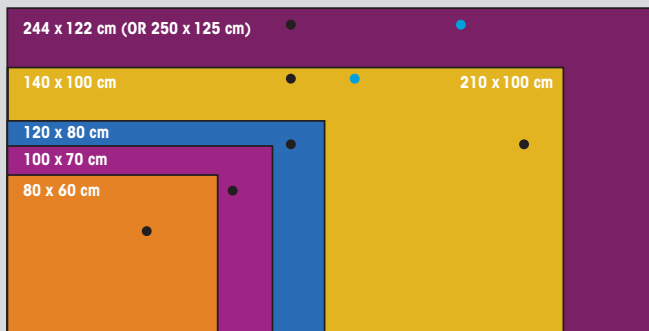

Océ Arizona 400 GT Series and Océ Arizona 600 GT Series European overlay zones

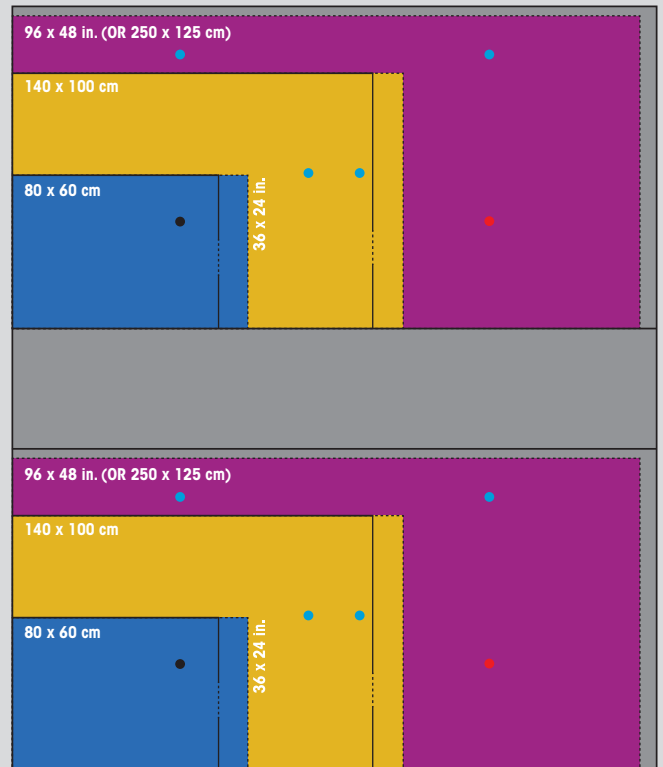

Océ Arizona XT and XTS Series European and U.S. overlay zones

BULK INK SYSTEM DESIGNED FOR PRODUCTIVITY

The UV curable ink is packaged in bulk ink bags, minimizing change-out. A quick-change ink system reduces waste, mess, and operator intervention. Intelligent ink bag sensing alerts the operator to an ink change requirement before running out of ink and ensures the correct ink color is installed. The temperature regulated ink system maintains consistent ink temperature and results in predictable, consistent viscosity for optimal printing, and making ambient temperature control less critical and much less expensive.

CMYK inks are available in two-liter packages for the Océ Arizona 400 Series and Océ Arizona 600 Series models, 800 ml packages for the Océ Arizona 318 GL model, and three-liter pouches for the Océ Arizona 6100 Series. White ink for Océ Arizona 400 Series, Océ Arizona 600 Series, and Océ Arizona 318 models equipped with this capability, is available in a one-liter package. White Ink is available in two-liter packages for the Océ Arizona 6170 Series. Varnish for select Océ Arizona 400 Series and Océ Arizona 600 Series models is available in a one-liter package.

COMPACT FOOTPRINT

The efficient footprint of Océ Arizona printers takes less room than competitive rigid-capable, roll-based units that require space on each side of the printer for media handling.

ROLL MEDIA OPTION

The Roll Media Option expands the functionality of the majority of Océ Arizona Series printers and increases opportunities for users by enabling roll-based printing of flexible media to create banners, point-of-sale displays, backlit graphics, paper-based posters, and fabric panels. The ability to exactly match print quality across a wide range of media gives users an edge in the competitive print-for-pay market when bidding on complex print campaigns. The Roll Media Option can be shipped with new orders or it can be added in the field—all existing Océ Arizona Series units with the exception of the Océ Arizona 6100 Series, can be upgraded without hardware modification.

CONTINUOUS PRODUCTION, ROLL TO RIGID AND BACK AGAIN

Unlike most competitive systems, the rigid and the roll printing areas do not interfere with each other. The two printing surfaces can be used sequentially. Once a rigid print is finished, the printhead assembly is positioned over the Roll Media Option and begins printing on flexible media. Meanwhile, the rigid material is swapped out and a new board is placed on the vacuum table and prepared for printing. Once the flexible media printing is completed, the printhead assembly moves back to the table to resume printing on the rigid media. There is absolutely no down time to reconfigure the system to change from one print mode to the other.



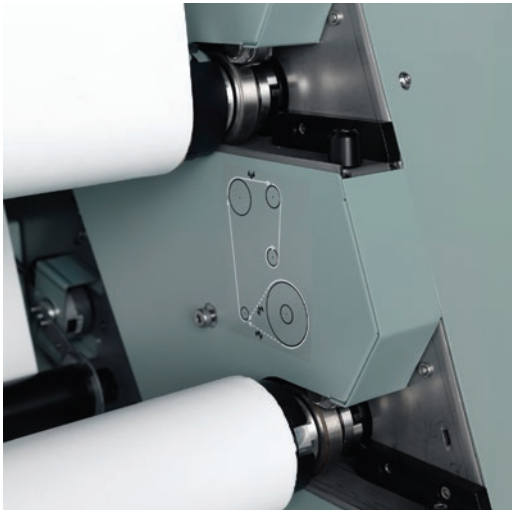

As an added benefit of this architectural approach, the Océ Arizona Series employs a patented technology in which the gantry assembly is actively moved forward or backward after each flexible media advance, making micro-corrections to compensate for media position. The printer precisely measures flexible media advance and then actively corrects for positional errors *before printing each and every swath* to ensure flexible media imaging of the highest possible quality. This technique is so effective that most Océ Arizona customers leave their printers running completely unattended, even overnight.

Patented and unique to Océ Arizona printers, this technology results in the highest quality roll media printing yet seen in a UV curable inkjet system. It greatly reduces the amount of wasted prints caused by media advance errors.

The Roll Media Option is a touch-free system— at no point does any part of the printer or the transport contact the printing surface of the media. Unlike roll-based systems that use pinch rollers, this feature enables customers to print on media sensitive to mechanical marking without marring the printing surface.

The Roll Media Option can support roll-based stock from 35.4 to 86.6 inches (0.9 to 2.2 meters) wide. Maximum print width is 86.2 inches (2.19 meters). A cutting guide slot is included to enable the user to cut media in a perfectly straight manner while viewing the finished print.

A wind/rewind foot panel to control roll-to-roll movement is included. This feature is used to advance and rewind media during loading and unloading and also enables the operator to view any part of the roll before cutting and dismounting.

WHITE INK

Océ Arizona printers can be equipped with White Ink, which enables underprinting for non-white media or objects, overprinting for backlit applications on transparent media and/or printing white as a spot color.

Under-printing white ink provides a base for non-white surfaces upon which color can be added, giving users the ability to expand their range of offerings to include specialty applications.

Over-printing white ink provides a diffusion layer for backlit applications that will be viewed from the unprinted side, enabling users to produce high quality backlit images for point-of-purchase applications. The ability to also print white ink as a spot color enables white features of images to be highlighted for greater effect.

WHITE INK LAYER OPTIONS

The white ink implementation in Océ Arizona printers enables users to specify how white ink is applied: below (printed first), above (printed last) or in-between colors. Users can also decide to use white as a spot color or as a flood layer. Most importantly users can decide to print multiple layers of white/color simultaneously, on the flatbed or on the Roll Media Option, using one, two or three layers of ink in total. This gives users the flexibility to create a wide range of applications on any rigid or flexible material. On the next page are some specific examples of the ways that white ink workflow can be applied.

White ink layer options

APPLICATION	BOTTOM	MIDDLE	TOP	NOTES
Backlit first surface (printing on the front side of the media)	White	CMYK	CMYK	CMYK layers contain same data
Backlit second surface (printing on the back side of clear media)	Reverse printed CMYK	Reverse printed CMYK	White	
Day-Night (first or second surface)	CMYK	White	CMYK	CMYK data is printed reverse or right-reading
Opaque	White	White	CMYK	3 layers
Opaque	<empty>	White	CMYK	2 layers

BACKLIT APPLICATION

The backlit application involves printing onto a transparent or translucent material and mounting the finished piece into a light box or a location where illumination from behind is possible. In the backlit application, white ink is intended to provide a light-diffusing layer. This application is possible using either two or three layers of ink; one layer of white ink printed above a layer of colored inks (viewed from the unprinted side) or one layer of white ink printed above two layers of colored inks for extra density (viewed from the unprinted side). It is rarely necessary to print two layers of white ink as a light diffusing layer but some backlit applications demand extra color density, so the ability to print multiple color layers combined with the white diffusing layer is important.

DAY-NIGHT APPLICATION

Similar to backlit, the day-night application also involves printing onto a transparent material. A day-night print can be viewed either front-lit or backlit. This is achieved by printing color data on two separate layers with a white flood fill printed as a diffusing layer between them. The ability of the Océ Arizona printer to lay down all three layers simultaneously during printing means that this application can be created using the flatbed table or Roll Media Option. This type of image can be backlit or front lit, and enables users to turn light boxes off during daylight hours for reduced energy consumption—a great ecological benefit for end-users.

OPAQUE APPLICATION

The opaque application involves printing CMYK data onto non-white media or objects. For this application, white ink is required both to enable the printer to produce images where white forms part of the image content, as well as to act as a base for the CMYK color set.

For White Ink enabled printers, included are tools in the Job Control module of the software to enable users to activate a graphical representation of the print layers, in order to verify the layer order.

DAY/NIGHT APPLICATION

Print color data on two separate layers onto transparent media with a white diffusing layer in the middle.



TOP:
FOUR-COLOR IMAGE



MIDDLE:
WHITE FLOOD FILL



BOTTOM:
FOUR-COLOR IMAGE

TRANSPARENT MEDIA



UP TO EIGHT INDEPENDENT INK CHANNELS

Océ Arizona 400 Series are available in three different models featuring four, six, or eight independent ink channels. Océ Arizona 600 Series are available in two different ink channel configurations—either four- or six-channels. The Océ Arizona 6100 Series is available in two different ink channel configurations—either six- or seven-channels. The entry level Océ Arizona 318 GL is available preconfigured from the factory as either 4-color (CMYK) or 4-color plus white.

With the exception of the Océ Arizona 6100 Series, on both the six- and eight-channel models, two channels can be configured in two ways that offer flexibility to meet the demands of various jobs:

- **Varnish + White:** With white ink, users can produce exceptional quality prints on a variety of non-white substrates—including backlit prints—that can command premium prices. Varnish can be used as a “spot” (targeted) or “flood” (overall) decorative element for attention-getting results at premium prices.
- **Double-White:** Alternatively, when not required for use in printing varnish, customers can use this as an additional white ink channel to provide double the opacity in a single printing pass for higher productivity when printing white ink jobs.

Customers can use these two channels in whichever configuration best suits their needs, changing from varnish + white to double-white (and vice versa) on demand.

On eight-channel Océ Arizona 480 printer or six-channel Océ Arizona 660 and 6100 Series printer models, two channels are used to enhance both print quality—beyond the award-winning level already available in every Océ Arizona printer—and with the Océ Arizona 480 and 660 models, the print speed by adding extra cyan and magenta nozzle capacity. Called CM² [C-M-squared], the additional cyan and magenta nozzle capacity offers Production print modes that rival the slower Quality-oriented modes in terms of sharpness, uniformity and smoothness. In short, CM² printing offers higher quality at faster speeds.

The six-channel Océ Arizona 6160 XTS provides CMYKcm and the seven-channel Océ Arizona 6170 XTS provides CMYKcm plus an additional white channel. Similar to the CM² configuration, the addition of light color inks in the Océ Arizona 6100 Series provides for even greater image quality at the high speeds attainable with that model series.



Printer basics

The Océ Arizona Series includes the following models:

6100 SERIES



Océ Arizona 6160 XTS printer



Océ Arizona 6170 XTS printer

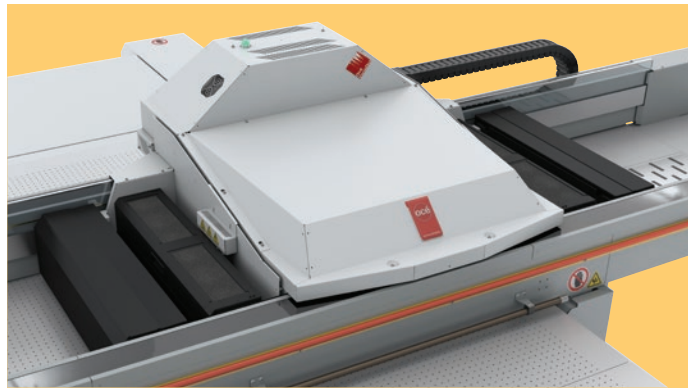

600 SERIES



Océ Arizona 660 XT printer



Océ Arizona 660 GT printer



Océ Arizona 640 XT printer



Océ Arizona 640 GT printer

400 SERIES



Océ Arizona 480 XT printer



Océ Arizona 480 GT printer

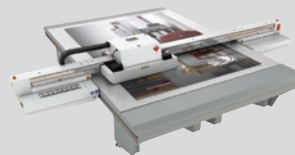

Océ Arizona 460 XT printer



Océ Arizona 460 GT printer



Océ Arizona 440 XT printer



Océ Arizona 440 GT printer



300 SERIES



Océ Arizona 318 GL printer

Océ Arizona Series UV flatbed printers

The table below reflects the main features and specifications of each model. An Express print mode is available on all models. Express mode features the same color density as other print modes and can be used for many applications. It is decidedly *not* a useless “draft” mode. On Océ Arizona 400 printer models, a High Definition print mode is available that delivers fine feature reproduction. Using this print mode, customers can offer higher-profit technical and industrial applications such as printing on lenticular panels and producing membrane switch panels.

MODEL SERIES, TABLE SIZE	OCÉ ARIZONA 6100 SERIES, EXTRA LARGE TABLE	OCÉ ARIZONA 600 SERIES, EXTRA LARGE TABLE	OCÉ ARIZONA 600 SERIES, STANDARD SIZE TABLE
			
AVAILABLE MODELS	OCÉ ARIZONA 6160 XTS PRINTER – with 6 ink channels	OCÉ ARIZONA 640 XT PRINTER – with 4 ink channels	OCÉ ARIZONA 640 GT PRINTER – with 4 ink channels
	OCÉ ARIZONA 6170 XTS PRINTER – with 7 ink channels	OCÉ ARIZONA 660 XT PRINTER – with 6 ink channels	OCÉ ARIZONA 660 GT PRINTER – with 6 ink channels
Rigid media size	98.4" x 120" (2.50 m x 3.05 m)	98.4" x 120" (2.50 m x 3.05 m)	49" x 98.4" (1.25 m x 2.50 m)
Rigid media thickness	2" (50.8 mm)	2" (50.8 mm)	2" (50.8 mm)
Océ VariaDot imaging technology	6 to 42 picoliter droplets, 636 nozzles, six printheads/color, dual row design	6 to 42 picoliter droplets, 636 nozzles, two printheads/color, dual row design	6 to 42 picoliter droplets, 636 nozzles, two printheads/color, dual row design
White Ink	Standard on Océ Arizona 6170 XTS printer	Standard on Océ Arizona 660 XT printer	Standard on Océ Arizona 660 GT printer
Varnish	Not available	Standard on Océ Arizona 660 XT printer	Standard on Océ Arizona 660 GT printer
CM² capability	Not available	Standard on Océ Arizona 660 XT printer	Standard on Océ Arizona 660 GT printer
PRINT MEDIA AND SPEEDS*			
Express print speed	1,668 ft. ² /hr. (155 m ² /hr.)	696 ft. ² /hr. (64.7 m ² /hr.)	657 ft. ² /hr. (60 m ² /hr.)
Production-Squared (CM²)	Not available	535 ft. ² /hr. (49.7 m ² /hr.) Océ Arizona 660 XT printer only	498 ft. ² /hr. (46.3 m ² /hr.) Océ Arizona 660 GT printer only
Production	1,076 ft. ² /hr. (100 m ² /hr.)	431 ft. ² /hr. (40 m ² /hr.)	404 ft. ² /hr. (37.5 m ² /hr.)
Quality-Squared (CM²)	Not available	358 ft. ² /hr. (33.3 m ² /hr.)	337 ft. ² /hr. (31.3 m ² /hr.)
Quality	775 ft. ² /hr. (72 m ² /hr.)	325 ft. ² /hr. (30.2 m ² /hr.)	306 ft. ² /hr. (28.4 m ² /hr.)
Fine Art	Not available	259 ft. ² /hr. (24.0 m ² /hr.)	244 ft. ² /hr. (22.7 m ² /hr.)
High definition	Not available	Not available	Not available
UV curing technology	497 mm, high output/low heat UV arc lamp with integrated shutter/reflector	171 mm, high output/low heat UV arc lamp with integrated shutter/reflector	171 mm, high output/low heat UV arc lamp with integrated shutter/reflector
Roll Media	Not available	Available option, up to 86.6" (2.2 m)	Available option, up to 86.6" (2.2 m)



OCÉ ARIZONA 400 SERIES, EXTRA LARGE TABLE	OCÉ ARIZONA 400 SERIES, STANDARD SIZE TABLE	OCÉ ARIZONA 300 SERIES, STANDARD SIZE TABLE
--	--	--



<p>OCÉ ARIZONA 440 XT PRINTER – with 4 ink channels</p>	<p>OCÉ ARIZONA 440 GT PRINTER – with 4 ink channels</p>	<p>OCÉ ARIZONA 318 GL PRINTER</p>
<p>OCÉ ARIZONA 460 XT PRINTER – with 6 ink channels</p>	<p>OCÉ ARIZONA 460 GT PRINTER – with 6 ink channels</p>	
<p>OCÉ ARIZONA 480 XT PRINTER – with 8 ink channels</p>	<p>OCÉ ARIZONA 480 GT PRINTER – with 8 ink channels</p>	
<p>98.4" x 120" (2.50 m x 3.05 m) 2" (50.8 mm)</p>	<p>49" x 98.4" (1.25 m x 2.50 m) 2" (50.8 mm)</p>	<p>49" x 98.4" (1.25 m x 2.50 m) 1.89" (48 mm)</p>
<p>6 to 42 picoliter droplets, 636 nozzles, one printhead/channel, single row design</p>	<p>6 to 42 picoliter droplets, 636 nozzles, one printhead/channel, single row design</p>	<p>6 to 42 picoliter droplets, 318 nozzles, one printhead/channel, single row design</p>
<p>Standard on Océ Arizona 480 XT printer and Océ Arizona 460 XT printer</p>	<p>Standard on Océ Arizona 480 GT printer and Océ Arizona 460 GT printer</p>	<p>Available option (factory only)</p>
<p>Standard on Océ Arizona 480 XT printer and Océ Arizona 460 XT printer</p>	<p>Standard on Océ Arizona 480 GT printer and Océ Arizona 460 GT printer</p>	<p>Not available</p>
<p>Standard on Océ Arizona 480 XT printer</p>	<p>Standard on Océ Arizona 480 GT printer</p>	<p>Not available</p>
<p>368 ft.²/hr. (34.2 m²/hr.)</p>	<p>353 ft.²/hr. (32.8 m²/hr.)</p>	<p>194 ft.²/hr. (18.0 m²/hr.)</p>
<p>272 ft.²/hr. (25.3 m²/hr.) Océ Arizona 480 XT printer only</p>	<p>264 ft.²/hr. (24.5 m²/hr.) Océ Arizona 480 GT printer only</p>	<p>Not available</p>
<p>226 ft.²/hr. (21.0 m²/hr.)</p>	<p>219 ft.²/hr. (20.3 m²/hr.)</p>	<p>131 ft.²/hr. (12.2 m²/hr.)</p>
<p>Not available</p>	<p>Not available</p>	<p>Not available</p>
<p>155 ft.²/hr. (14.4 m²/hr.)</p>	<p>151 ft.²/hr. (14.0 m²/hr.)</p>	<p>90 ft.²/hr. (8.4 m²/hr.)</p>
<p>126 ft.²/hr. (11.7 m²/hr.)</p>	<p>122 ft.²/hr. (11.3 m²/hr.)</p>	<p>68 ft.²/hr. (6.3 m²/hr.)</p>
<p>66 ft.²/hr. (6.1 m²/hr.)</p>	<p>64 ft.²/hr. (5.9 m²/hr.)</p>	<p>Not available</p>
<p>110 mm, high output/low heat UV arc lamp with integrated shutter/reflector</p>	<p>110 mm, high output/low heat UV arc lamp with integrated shutter/reflector</p>	<p>110 mm, high output/low heat UV arc lamp with integrated shutter/reflector</p>
<p>Available option, up to 86.6" (2.2 m)</p>	<p>Available option, up to 86.6" (2.2 m)</p>	<p>Available option, up to 86.6" (2.2 m)</p>

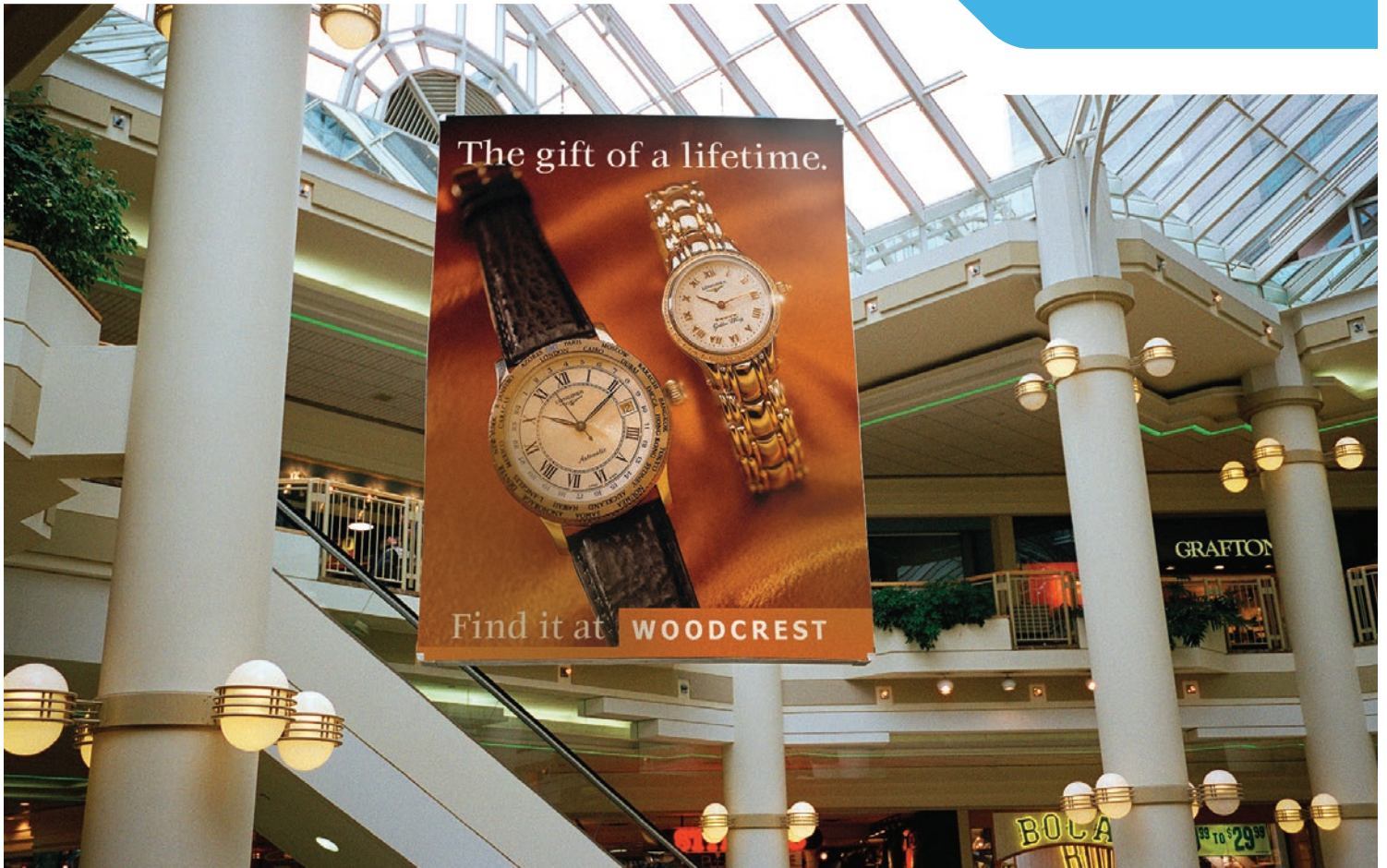

UPGRADE PATH

Océ Arizona 400 Series printers include six different UV flatbed models featuring four, six, or eight independent ink channels in two different flatbed sizes. The Océ Arizona 600 Series printers include four different UV flatbed models featuring four or six independent ink channels in two different flatbed sizes. The Océ Arizona 6100 Series printers include two models featuring six or seven independent ink channels. An upgrade path is available to ensure that the investment in an Océ Arizona 400 Series printer, Océ Arizona 600 Series printer, or Océ Arizona 6100 Series printer is protected from obsolescence.

Océ Arizona 440 GT printer, Océ Arizona 640 GT printer, Océ Arizona 440 XT printer, and Océ Arizona 640 XT printer models include CMYK ink channels only, for those shops that do not initially need the capacity for Varnish or White Ink printing. Similarly, the Océ Arizona 6160 XTS supports CMYKcm with no White Ink channel. All these Océ Arizona printer models are designed to grow with a print service provider's business. Owners can upgrade at any time to add more application versatility and improve productivity.

THE FOLLOWING UPGRADES ARE AVAILABLE¹:

- Océ Arizona 440 printer to Océ Arizona 460 printer adds Varnish + White or Double-White capability
- Océ Arizona 460 printer to Océ Arizona 480 printer adds CM² capability
- Océ Arizona 440 printer to Océ Arizona 480 printer adds Varnish + White or Double-White capability, plus CM² capability
- Océ Arizona 640 printer to Océ Arizona 660 printer adds Varnish + White or Double-White or CM² capability
- Océ Arizona 6160 XTS printer to Océ Arizona 6170 XTS printer adds White capability

¹ Upgrades apply only to ink configurations, not table sizes. Océ Arizona GT printer tables cannot be upgraded to Océ Arizona XT printer tables.



IDEAL FOR PRINT-AND-CUT APPLICATIONS

Because of the stationary vacuum table and generous media thickness allowance of all Océ Arizona Series printers, print-and-cut jobs have become key applications for print service providers. Paired with a digital cutting system, such as a Zünd G3 cutter, the two can be used to produce point-of-sale structural displays, exhibit furniture, packaging prototypes and more.

MEET NEARLY ANY PRINTING NEED

If a job can be printed digitally, it most likely can be produced on an Océ Arizona Series printer. With the ability to print on a wide variety of media and objects, print service providers can capture revenue from applications ranging from standard sign and display (POP, retail signage, backlit signs) to specialty and industrial applications where the decorated substrate is not meant primarily for display purposes (e.g. package prototyping, short-run packaging, wallpaper and interior decoration, and consumer product decoration).

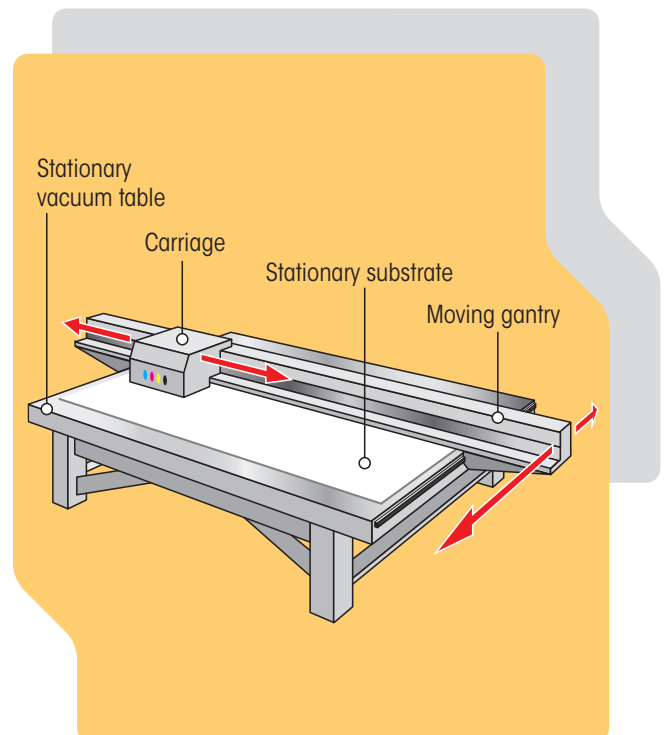

Océ Arizona Series Awards



Creating global leadership in printing

Canon and Océ join forces to create the global leader in the printing industry. For our customers this combines Canon and Océ technology with the support of the Océ direct sales and service organizations. Look to the new Canon-Océ combination for:

- Enterprise printing in the office and corporate printroom
- Large format printing of technical documentation, signage and display graphics
- Production printing for marketing service bureaus and graphic arts
- Business services for document process outsourcing

For information and services, visit us at:

www.csa.canon.com

Partners Certifications



Canon

CANON SOLUTIONS AMERICA

Large Format Solutions

100 Park Boulevard
Itasca, Illinois 60143

1-800-714-4427 | 1-630-250-6550

email: us.info@csa.canon.com

ODGS-1339 DS 7/14 CC1/PDF